

UNI-T®

UTG900E Series Function Generator User Manual

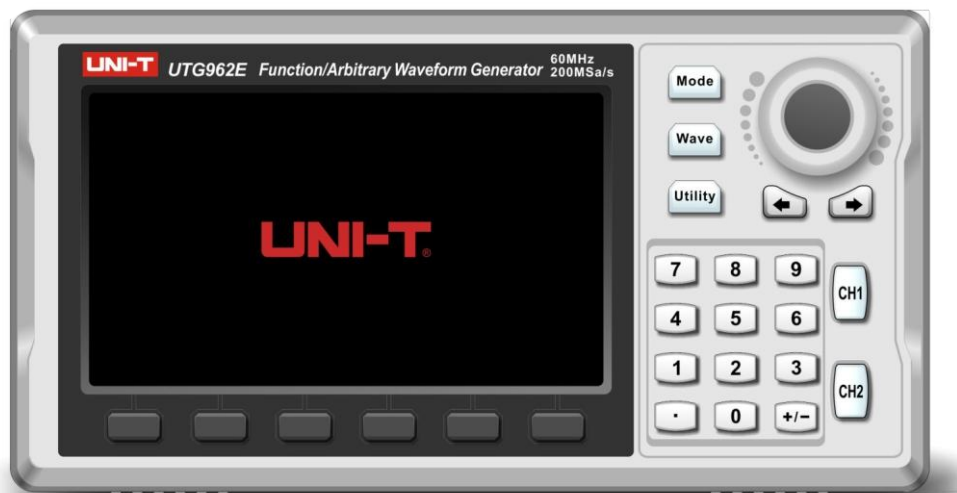

www.uni-trend.com

Preface

Thank you for purchasing the new function generator. In order to use this product safely and correctly, please read this manual thoroughly, especially the Safety Information part.

After reading this manual, it is recommended to keep the manual at an easily accessible place, preferably close to the device, for future reference.

Copyright Information

Uni-Trend Technology (China) Co., Ltd, all rights reserved.

UNI-T products are protected by patent rights in China and other countries, including issued and pending patents.

Uni-Trend reserves the rights to any product specification and pricing changes.

Uni-Trend reserves all rights. Licensed software products are properties of Uni-Trend and its subsidiaries or suppliers, which are protected by national copyright laws and international treaty provisions. Information in this manual supersedes all previously published versions.

UNI-T is the registered trademark of Uni-Trend Technology (China) Limited.

Uni-Trend warrants that this product will be free from defects for a three-year period. If the product is resold, the warranty period will be from the date of the original purchase from an authorized UNI-T distributor. Probes, other accessories, and fuses are not included in this warranty.

If the product is proved to be defective within the warranty period, Uni-Trend reserves the rights to either repair the defective product without charging any parts or labor, or exchange the defected product to a working equivalent product. Replacement parts and products may be brand new, or perform at the same specifications as brand new products. All replacement parts, modules, and products are the property of Uni-Trend.

The "customer" refers to the individual or entity that is declared in the guarantee. In order to obtain the warranty service, "customer" must inform the defects within the applicable warranty period to UNI-T, and to perform appropriate arrangements for the warranty service. The customer shall be responsible for packing and shipping the defective products to the designated maintenance center of UNI-T, pay the shipping cost, and provide a copy of the purchase receipt of the original purchaser. If the product is shipped domestically to the location of the UNI-T service center, UNI-T shall pay the return shipping fee. If the product is sent to any other location, the customer shall be responsible for all shipping, duties, taxes, and any other expenses.

This warranty shall not apply to any defects or damages caused by accidental, machine parts' wear and tear, improper use, and improper or lack of maintenance. UNI-T under the provisions of this warranty has no obligation to provide the following services:

- a) Repair any damage caused by the installation, repair, or maintenance of the product by non UNI-T service representatives.
- b) Repair any damage caused by improper use or connection to an incompatible device.
- c) Repair any damage or malfunction caused by the use of a power source which does not conform to the requirements of this manual.
- d) Any maintenance on altered or integrated products (if such alteration or integration leads to an increase in time or difficulty of product maintenance).

This warranty is written by UNI-T for this product, and it is used to substitute any other expressed or implied warranties. UNI-T and its distributors do not offer any implied warranties for merchantability or applicability purposes.

For violation of this guarantee, UNI-T is responsible for the repair or replacement of defective products is the only remedy available to customers. Regardless of whether UNI-T and its distributors are informed that any indirect, special, incidental, or consequential damage may occur, the UNI-T and its distributors shall not be responsible for any of the damages.

Table of Contents

Preface	2
Copyright Information	3
Table of Contents	4
Chapter 1 Safety Information	5
1.1 Safety Terms and Symbols	5
1.2 General Safety Overview	5
Chapter 2 Introduction	6
2.1 Main Feature	6
2.2 Output Features	6
2.3 Panels and Buttons Introduction	7
2.3.1 Front Panel	7
2.3.2 Left and Right Panel	8
2.3.3 Function Interface	9
3.1 General Inspection	10
3.1.2 Check Accessories	10
3.1.3 Inspect the Device	10
3.2 Basic Waveform Output	10
3.2.1 Set Output Frequency	10
3.2.2 Set Output Amplitude	10
3.2.3 Set DC Offset Voltage	10
3.2.4 Set Phase	10
3.2.5 Set Pulse Wave Duty Ratio	10
3.2.6 Set Ramp Symmetry	10
3.2.7 Set DC Voltage	11
3.2.8 Set Noise Wave	11
3.3 Utility Settings	11
3.3.1 Channel Settings	11
3.3.2 Frequency Counter	11
3.3.3 System Settings	12
Chapter 4 Advanced Applications	14
4.1 Generate Modulation Waveform	14
4.1.1 Amplitude Modulation (AM)	14
4.1.2 Phase Modulation (PM)	18
4.1.3 Frequency Modulation (FM)	22
4.1.4 Frequency Shift Keying (FSK)	26
4.2 Output Frequency Sweep Waveform	30
4.2.1 Select Frequency Sweep	30
4.2.2 Set Starting and Stop Frequency	31
4.2.3 Frequency Sweep Mode	32
4.2.4 Frequency Sweep Time	32
4.2.5 Comprehensive Example	32
4.3 Output Arbitrary Wave	34
4.3.1 Enable Arbitrary Wave Function	34
4.3.2 Select Arbitrary Wave	35
Chapter 5 Fault Handling	36
Chapter 6 Service and Support	36
6.1 Outline of Warranty	36
6.2 Contact Us	36
Appendix A: Factory Reset State	37
Appendix B: Performance Index	39
Appendix C: List of Accessories	43
Appendix D: Maintenance and Cleaning	43

Chapter 1 Safety Information

1.1 Safety Terms and Symbols

The following terms may appear in this manual:

Warning: The conditions and behaviors may endanger life.

Note: The conditions and behaviors may cause damage to the product and other properties.

The following terms may appear on the product:

Danger: This operation may cause immediate damage to the operator.

Warning: This operation may cause potential damage to the operator.

Note: This operation may cause damage to the product and devices connected to the product.

The following symbols may appear on the product:

	Alternating Current
	Caution, Possibility of Electric Shock
	Warning or Caution
	Comply with European Union Standards
	Conforms to UL STD. 61010-1,61010-2-030,Certified to CSA STD C22.2 NO.61010-1,61010-2-030
	Equipment protected throughout by DOUBLE INSULATION

1.2 General Safety Overview

This instrument strictly complies with the GB4793 safety requirements for electrical equipment and IEC61010-1 safety standard during design and manufacturing. It complies with the safety standards for insulated over voltage CAT II 300V and pollution level II.

Please read the following safety preventative measures:

- To avoid electric shock and fire, please use the dedicated UNI-T power supply appointed to the local region or country for this product.
- To avoid personal injury and prevent damaging the product, only trained personnel can perform the maintenance program.
- To avoid fire or electric shock, please notice rated operating range and product marks.
- Please check the accessories for any mechanical damage before usage.
- Only use accessories that came with this product.
- Please do not put metal objects into the input and output terminals of this product.
- Do not operate the product if you suspect it is faulty, and please contact UNI-T authorized service personnel for inspection.
- Please do not operate the product when the instrument box opens.
- Please do not operate the product in humid conditions.
- Please keep the product surface clean and dry.

Chapter 2 Introduction

This series of devices are economical, high-performance, multi-functional arbitrary waveform generators that use direct digital synthesis (DDS) technology to produce accurate and stable waveforms. UTG900 can generate accurate, stable, pure and low distortion output signals. UTG900's convenient interface, superior technical indexes and user-friendly graphical display style can help users to complete study and test tasks quickly and improves work efficiency.

2.1 Main Feature

- Frequency output of 60MHz/30MHz, full-band resolution of 1 μ Hz
- Use direct digital synthesis (DDS) method, sampling rate of 200MSa/s and vertical resolution of 14 bits
- Low jitter square wave output
- TTL level signal compatible 7 digits high accuracy frequency counter
- 24 groups non-volatile arbitrary waveform storage
- Simple and useful modulation types: AM, FM, PM, FSK
- Support frequency scanning and output
- Powerful upper computer software
- 4.3 inches TFT color screen
- Standard configuration interface: USB Device
- Easy-to-use multi-functional knob and numeric keypad

2.2 Output Features

Channel	CH1, CH2
Amplitude range	1mVpp~10Vpp (50 Ω)
Waveform	Sin wave, square wave, pulse wave, ramp wave, noise, DC
Modulation types	AM, FM, PM, FSK
Sweep frequency	Log, Line

2.3 Panels and Buttons Introduction

2.3.1 Front Panel

The product provides users with a simple, intuitive, and easy-to-use front panel, as shown below:

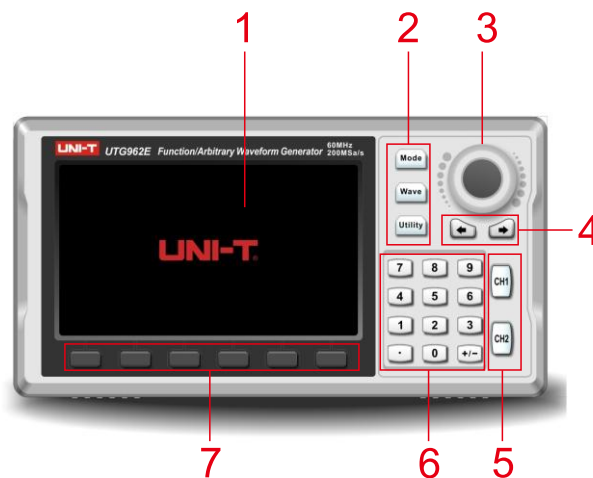

1. Display screen

4.3 inches TFT color LCD screen distinguishes the output status, function menu and other key information of CH1 and CH2 by various colors. User-friendly graphical display style improves work efficiency.

2. Function keys

There are function keys of **Mode**, **Wave** and **Utility**, users can set modulation, fundamental wave and auxiliary functions by these keys.

3. Multi-functional knob

Adjust the multi-functional knob to change digits (clockwise to increase) or use the knob as direction key, press the multi-functional knob to select the functions or set parameters.

4. Direction keys

Use the direction keys to switch digits, backspace, delete the previous digits or move the cursors.

5. **CH1/CH2** output control key

Switch current channel. If CH1 label is highlighted, the current channel is CH1 (CH1 waveform parameters will be displayed and adjustable), users can press **CH1/CH2** to enable/close the channel output, or press **Utility** and the soft key to set. Backlight of the **CH1/CH2** will be turned on when the channel is opened, and displays output function mode with signal output, otherwise the backlight will be off, OFF is displayed on label and the output is closed.

6. Numeric keyboard

Used to enter the required parameters, including numeric keys 0 to 9, decimal point ".", and symbolic keys "+/-". Press the left direction key to backspace and delete the previous digits.

7. Menu operating key

Select or check the corresponding label content below the function interface, and set the parameters by numeric keyboard, multi-functional knob and direction keys.

⚠ Note:

- The channel output overvoltage protection will be enabled if any condition below is met.
- Set the range over 250mVpp, input voltage over $|\pm 12.5V|$, frequency less than 10kHz.
- Set the range no less than 250mVpp, input voltage over $|\pm 2.5V|$, frequency less than 10kHz.
- The channel will automatically disconnect if the overvoltage protection is triggered.

2.3.2 Left and Right Panel

As shown below:

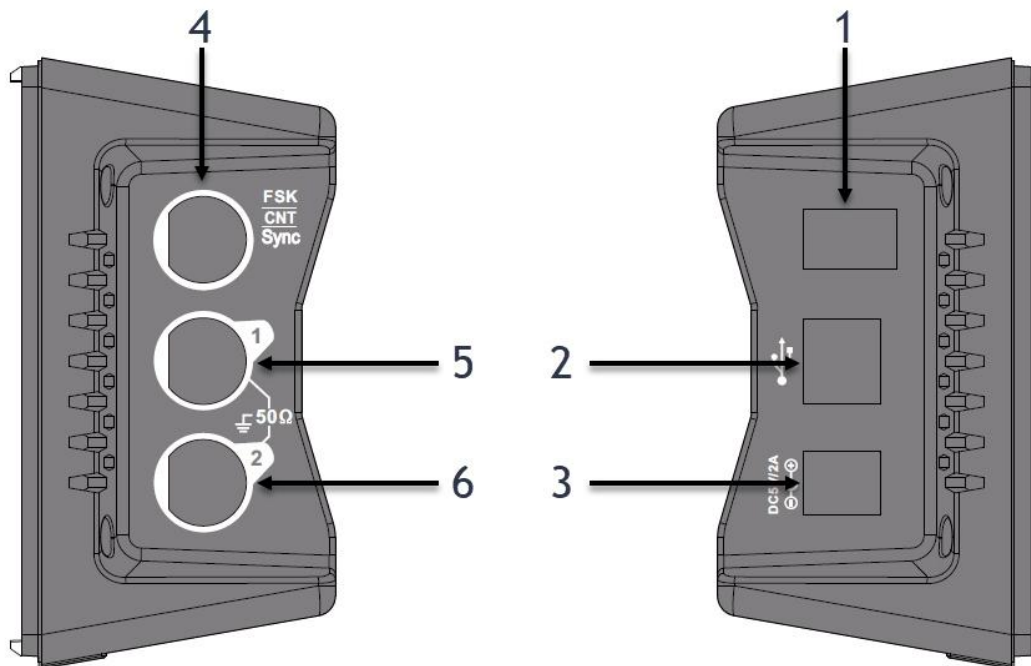

1. Power switch

- Switch it to the “I” to turn the device on, and switch it to “O” to turn it off.

2. USB interface

- Connect the device with the upper computer

3. DC power supply port

- The rated input of this product is 5V, 2A. High SNR signal output from function generator is needed. Official standard power adapter is recommended.

4. Sync output port/frequency counter input port/external digital modulation interface

- Same port is applied for sync output, the frequency counter input and external digital modulation interface. Only when the sync output is closed, the frequency counter is allowed to enable.

5. CH1 output

- CH1 output interface

6. CH2 output

- CH2 output interface

2.3.3 Function Interface

As shown below:

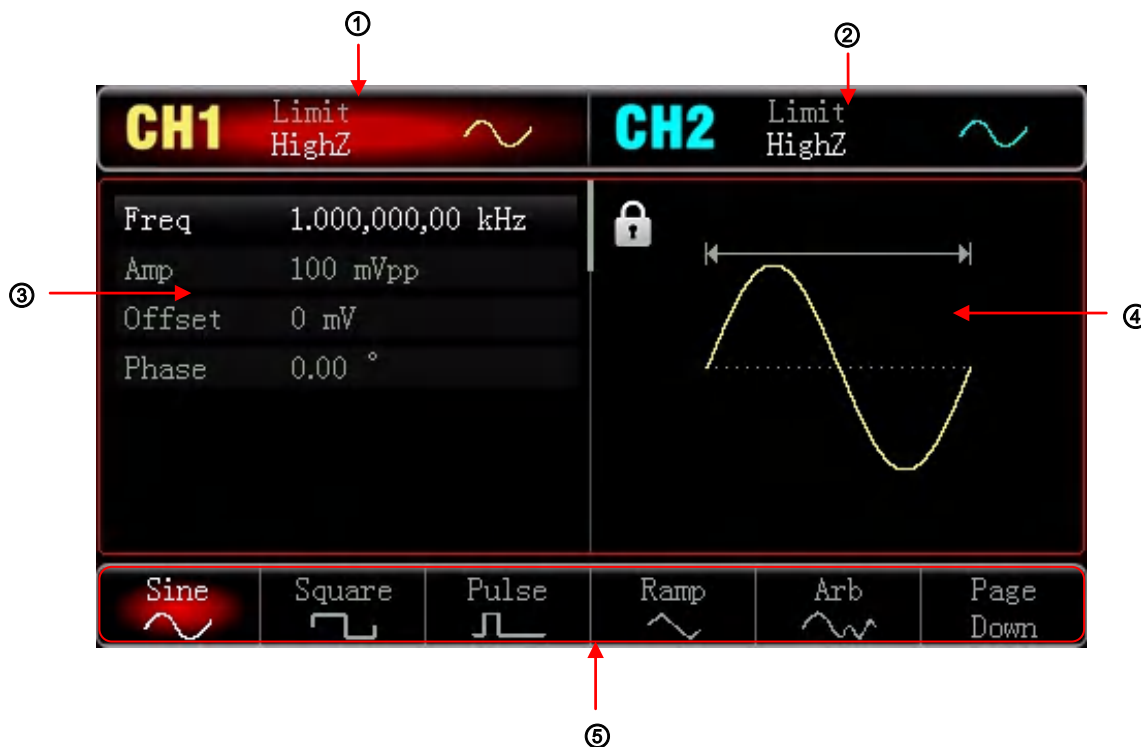

1. CH1 information, the selected channel will be highlighted.

HighZ indicates the matched impedance of output terminal (1Ω to 9999Ω adjustable or high resistance; defaults to HighZ)

 : sine wave currently (Different modes have different menu)

2. CH2 information, as same as Ch1

3. Waveform parameters list

The parameters of current waveform are listed, if one item of the list is displayed at white, users can set its parameters through the menu operating keys, numeric keypad, direction keys and multi-functional knob. If the under-painting of selected word is the same as current channel (white in system setting), indicates that the word is in edit mode.

4. Waveform display area

Displays waveform of current setting channel which can be distinguish by highlighted information label, and its parameters are displayed on the left side. The waveform display area will display parameters list during system setting.

5. Soft key label

Identify the current function of soft keys.

The middle of current function label will be highlighted with corresponding color of current channel, or goes with grey color and white font during system setting.

Chapter 3 Quick Start

3.1 General Inspection

It is recommended to follow the steps below to check the instrument before using this device for the first time.

3.1.1 Check for Damages Caused by Transport

If the packaging carton or foamed plastic cushions are severely damaged, please contact the UNI-T distributor of this product or local office.

If the instrument is damaged by transport, please keep the package and notify transport department and the UNI-T distributor who will arrange repair or replacement.

3.1.2 Check Accessories

The accessories of UTG900 include: a power adapter, a BNC cable (1m) and a BNC-alligator clip cable. If any of these accessories is missing or damaged, please contact your distributor or UNI-T local office.

3.1.3 Inspect the Device

If the instrument appears to be damaged, runs abnormally or fails the functionality tests, please contact your distributor or UNI-T local office.

3.2 Basic Waveform Output

3.2.1 Set Output Frequency

The default waveform is a sine wave of 1kHz frequency and 100mVpp amplitude (terminating at 50Ω).

The specific steps for changing frequency to 2.5MHz are as follows:

Press the **Wave** → **Sine** → **Freq** in sequence and enter 2.5 by numeric keypad, select the parameter unit **MHz**.

3.2.2 Set Output Amplitude

The default waveform is a sine wave of 100mVpp amplitude (terminating at 50Ω). The specific steps for changing amplitude to 300mVpp are as follows:

Press the **Wave** → **Sine** → **Amp** and enter 300 by numeric keypad, select the parameter unit **mVpp**.

3.2.3 Set DC Offset Voltage

The default waveform is a sine wave with 0V DC offset voltage (terminating at 50Ω). The specific steps for changing DC offset voltage to -150mV are as follows:

Press the **Wave** → **Sine** → **Offset**, and enter -150 by numeric keypad, select the parameter unit **mVpp**.

Note: This parameter can also set by multi-functional knob and the direction keys.

3.2.4 Set Phase

The default phase of the waveform is 0°. To set the phase to 90°, press the **Phase**, and enter 90 by numeric keypad, select the parameter unit **°**.

3.2.5 Set Pulse Wave Duty Ratio

The pulse wave default frequency is 1kHz, duty ratio is 50%. To set the duty ratio (limited by the minimum pulse width of 80ns) to 25%, the specific steps are as follows:

Press **Wave** → **Pulse** → **Duty**, enter 25 by numeric keypad, and select the parameter unit **%**.

3.2.6 Set Ramp Symmetry

The ramp wave default frequency is 1kHz. To set the triangular wave with symmetry of 75%, the specific steps are as follows:

Press **Wave** → **Ramp** → **Symmetry**, enter 75 by numeric keypad, and select the parameter unit **%**.

3.2.7 Set DC Voltage

The default DC voltage is 0V, and the specific steps to change it to 3V are as follows:

Press **Wave** → **Page down** → **DC**, enter 3 by numeric keypad, and select the parameter unit **V**.

3.2.8 Set Noise Wave

The default noise is quasi-Gaussian noise with amplitude of 100mVpp and DC offset of 0V. the specific steps to set the quasi-Gaussian noise with amplitude of 300mVpp and DC offset of 1V:

Press **Wave** → **Page down** → **Noise** → **Amp**, enter 300 by numeric keypad, and select the parameter unit **mV**. Then press **Offset**, enter 1, and select the parameter unit **V**.

3.3 Utility Settings

The utility settings can be used to adjust and check the channel setup, sync output, frequency counter, system, backlight, language, default setting, help menu, Screen Lock, and system information, The machine connected to the host computer can press this button to unlock.

The specific functions are as follows:

3.3.1 Channel Settings

Function menu	Function submenu	Setting	Description
CH1 setting CH2 setting	Channel output	On/off	
	Channel reverse	On/off	
	Load	50Ω,	1Ω-9999Ω
	Amplitude limit	high resistance	
	Upper limit of amplitude	On/off	Set the upper limit of the channel amplitude output
	Lower limit of amplitude		Set the lower limit of the channel amplitude output

Press **Utility** → **CH1 Setting** or **CH2 Setting** to set the channels:

1. Output

Set the channel output to “On” or “Off” (Note: press the **CH1** and **CH2** on front panel to open the channel output quickly).

2. Inversion

Set the channel inversion to “On” or “Off”.

3. Load

Select the load between 1-9999Ω, **50Ω**, **75Ω** and **HighZ** are also selectable.

4. Amp limit

Amplitude limited output is supported in order to protect the load. Set the amplitude limit to “On” or “Off”.

5. Upper limit

Select the upper limit of amplitude

6. Lower limit

Select the lower limit of amplitude

3.3.2 Frequency Counter

This instrument can measure the duty ratio and frequency of TTL-compatible level signal, with frequency range of 100mHz-100MHz.

When we use the frequency counter function, the TTL-compatible level signal inputs through an external digital modulation or frequency counter interface (INPUT/CNT/Sync connector)

Press **Utility** → **Counter**, read the signal values of **Freq**, **Period** and **Duty**. When there is no signal input, the counter parameter list will display the value measured before. Only when TTL-compatible level signal is inputted through external digital modulation/frequency counter interface (INPUT/CNT/Sync connector), the frequency counter refreshes display.

3.3.3 System Settings

Function menu	Function submenu	Settings	Description
System	Sync Output	CH1, CH2, off	
	Phase Sync	Independent, sync	
	Language	English, simplified Chinese	
	Beep	On, off	
	Num Format	Comma, space, none	
	Backlight	10%, 30%, 50%, 70%, 90%	
	Screen Lock	Off, 1 min, 5 min, 15 min, 30 min., 1h	
	Preset		Reset to the factory setting
	Help		Help text
	About		Displays model, version and company website

Press **Utility** → **System** to enter the system setting.

Note: Press **Page Down** if need to flip over.

1.Sync output

Set the sync output to **CH1**, **CH2** or **Off**.

2.Phase sync

Set the initial phase to **Independent** or **Sync**. **Independent** means there is no association between output phase of CH1 and CH2 while **Sync** means there are synchronization between phases.

3. Language

Set the device language to English or simplified Chinese.

4. Beep

Set the key pressing sound to "On" or "Off".

5. Num Format

Set the separator between numbers, press **NumFormat** to select **Comma**, **Space** or **None**.

6. Backlight

Adjust the brightness of screen, press **Backlight** to select between **10%**, **30%**, **50%**, **70%**, **90%** and **100%**.

7. Screen Lock

Press **ScreenLock** and select Off, 1 min, 5 min, 15 min, 30 min or 1h. The instrument will be turned to screen lock state, the Mode button will blink, press any button to restore.

8. Preset

Reset to the factory setting

9. Help

The built-in help system provides contextual help for any of the buttons or menu soft keys on the front panel. You can also use help list to get some help information about front panel operations. Long press any soft key or button to open the help list, such as **Wave**, press any key or knob to exit help list.

10. About

Press to check the device model, version and the official website of the company.

Chapter 4 Advanced Applications

This chapter introduces the AM, PM, FM and FSK modulation. Press **Mode** to enter modulation, and press **Mode** again to exit.

4.1 Generate Modulation Waveform

4.1.1 Amplitude Modulation (AM)

In AM modulation, modulated waveform is usually composed of carrier wave and modulation wave. The modulation of CH1 and CH2 are independent, you can set up the same or different mode for them.

- **Select **AM** Modulation**

Press **Mode** → **AM** to enable the AM function, then the device will output modulated waveform with current set modulation waveform and carrier wave.



- **Select Carrier Waveform**

After select the **AM** modulation, press **Wave** to select carrier waveform, which can be: sine (default), square, ramp or arbitrary wave.

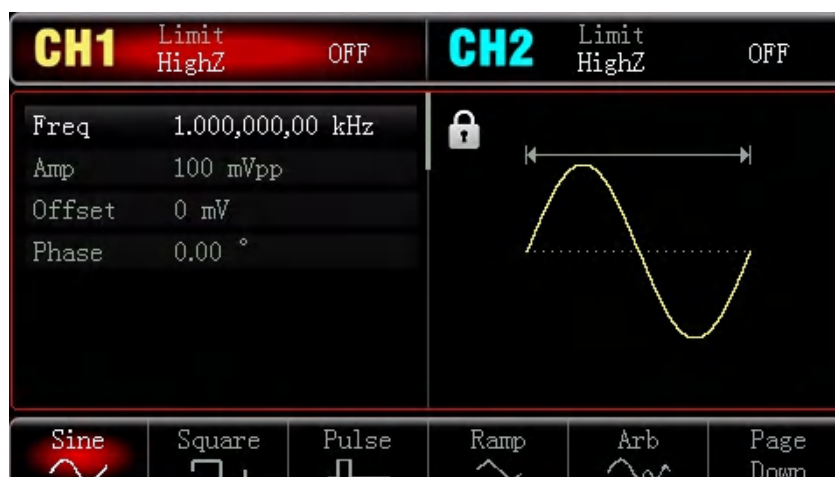

● Set Carrier Wave Frequency

Default frequency is 1kHz. Different carrier waveform has different settable frequency range.

Carrier waveform	Frequency			
	UTG932E		UTG962E	
	Maximum	Minimum	Maximum	Minimum
Sine wave	1μHz	30MHz	1μHz	60MHz
Square wave	1μHz	15MHz	1μHz	20MHz
Ramp wave	1μHz	400kHz	1μHz	400kHz
Pulse wave	1μHz	15MHz	1μHz	20MHz
Arbitrary wave	1μHz	10MHz	1μHz	10MHz

Use multi-functional knob to set carrier wave frequency after select carrier wave, or press **Freq** then enter number by numeric keypad to set.

● Select Modulation Wave

Modulation source of device is internal. And modulation wave can be: sine (default), square, rising/falling ramp, arbitrary wave or noise. After enabling AM function, the default modulation source can be modified by multi-functional knob or press **ModWave**.

- Square wave: duty ratio is 50%
- Rising ramp wave: symmetry degree is 100%
- Falling ramp wave: symmetry degree is 0%
- Arbitrary wave: when arbitrary wave is selected to be modulation wave, function/arbitrary waveform generation limits arbitrary wave length as 4kpts through auto snapshot.
- Noise: White gauss noise



● Set Modulation Wave Frequency

Set the modulation wave frequency in range of 2mHz~200kHz (default to 100Hz). After enabling AM function, the default modulation wave frequency can be modified by multi-functional knob or press ModFreq, enter the number by numeric keypad and select unit.

● Set Modulation Depth

Modulation depth indicates the extent of amplitude variation which is expressed as percentage. The range of AM modulation depth is 0%~120% (default to 100%)

- When modulation depth is 0%, constant amplitude is output (half of the set carrier amplitude).
- When modulation depth is 100%, the output amplitude varies with the modulation waveform.
- When modulation depth is greater than 100%, the output amplitude of the instrument will not exceed 10Vpp (50Ω load).

After enabling AM function, the modulation depth can be modified by multi-functional knob or press **Depth**, enter the number by numeric keypad and select unit.

● Comprehensive Example

First run the instrument in amplitude modulation (AM) mode, then set an internal sine wave of 200Hz as the modulation signal and a pulse wave with frequency of 10kHz, amplitude of 200mVpp and duty ratio of 45% as the carrier wave signal. Finally set modulation depth to be 80%. The specific steps are as follows:

1) Enable Amplitude Modulation (AM) Function

Press **Mode** → **AM** to enable **AM** function.



2) Set Modulation Signal Parameters

After step 1), press **ModFreq**, enter 200, and select the parameter unit **Hz**.



3) Set Waveform and Parameter of Carrier Wave Signal

Press **Wave** → **Square** to select the square wave as carrier waveform (default to sine wave).

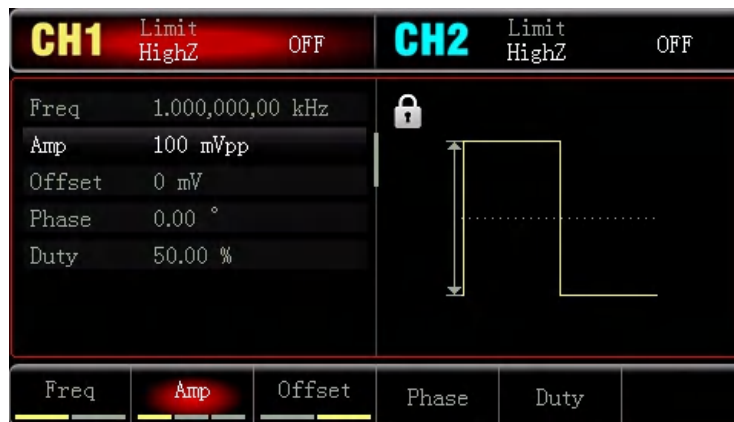

Press **Freq** to set the frequency, enter 10 by numeric keypad, and select the parameter unit **kHz**.
 Press **Amp** to set the amplitude, enter 200 by numeric keypad, and select the parameter unit **mVpp**.
 Press **Duty** to set the duty ratio, enter 45 by numeric keypad, and select the parameter unit **%**.
 As shown below:



4) Set Modulation Depth

After setting carrier wave and parameters, press **Mode** → **AM** to enter the amplitude setting.
 Press **Depth**, enter 80 and select the parameter unit **%** for setting modulation depth.



5) Enable Channel Output

Press **CH1** to enable the channel 1 output quickly. Backlight of the CH1 key will be turn on.

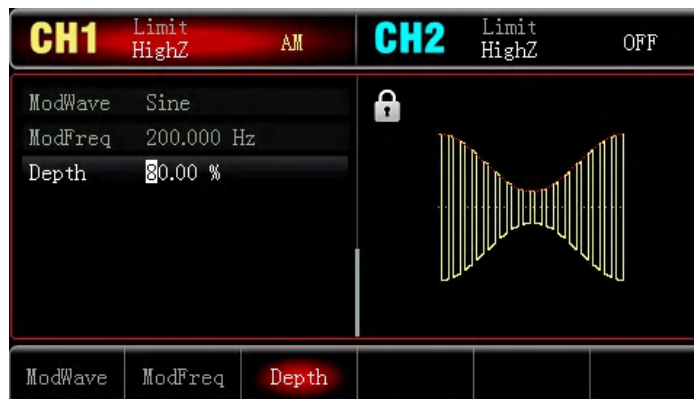

The AM modulation waveform in oscilloscope is shown below:

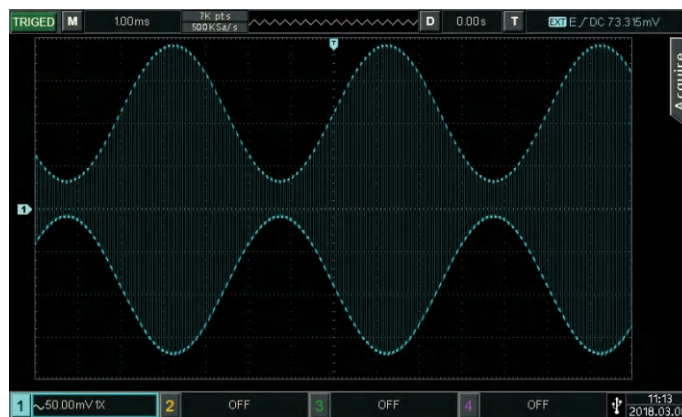

4.1.2 Phase Modulation (PM)

In phase modulation, modulated waveform is usually composed of carrier wave and modulation. The phase of carrier wave varies with amplitude of modulation wave.

Press **Menu** → **PM** to turn on the PM function, the device will output modulated waveform with current set modulation waveform and carrier wave.

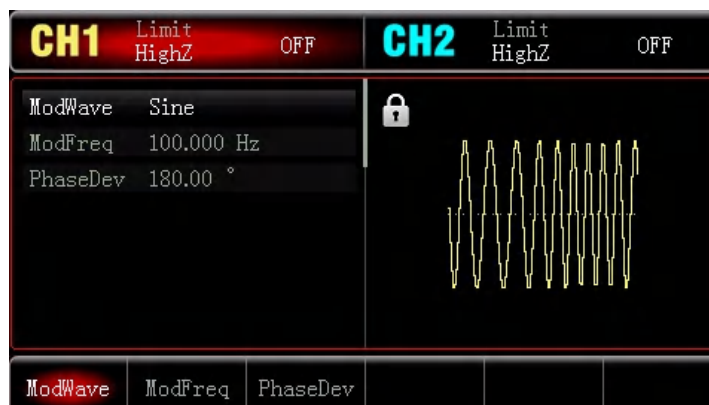

● Select Carrier Waveform

PM carrier waveform can be: sine wave (default), pulse wave, ramp wave or arbitrary wave. After selecting the PM modulation, press **Wave** to select carrier waveform.



● Set the Carrier Frequency

Please refer to the AM carrier waveform setting.

● Select the Modulation Wave

Modulation source of device is internal. And modulation wave can be: sine wave (default), square wave, rising/falling ramp wave, arbitrary wave or noise. After enabling PM function, the default modulation source can be modified by multi-functional knob or press **ModWave**.

- Square wave: duty ratio is 50%
- Rising ramp wave: symmetry degree is 100%
- Falling ramp wave: symmetry degree is 0%
- Arbitrary wave: when arbitrary wave is selected to be modulation wave, function/arbitrary waveform generation limits arbitrary wave length as 4kpts through auto snapshot.
- Noise: White gauss noise

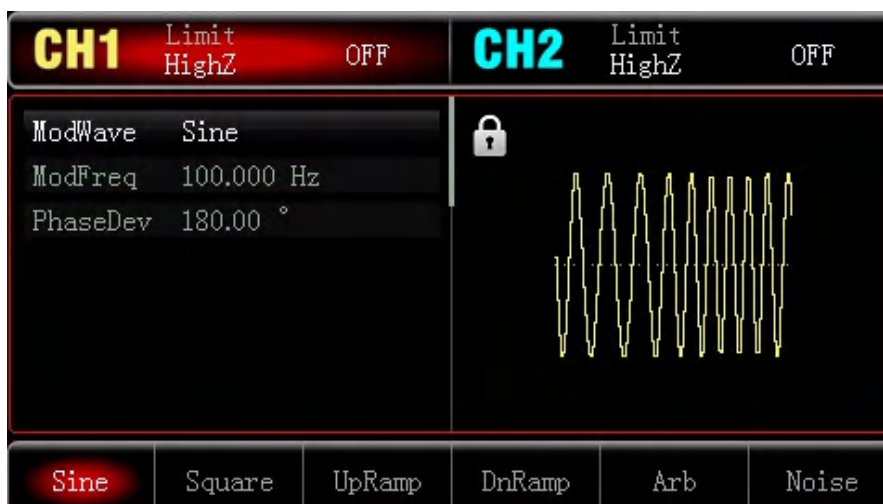

● Set Modulation Wave Frequency

Set the modulation wave frequency, range is 2mHz~200kHz (default to 100Hz). After enabling PM function, the default modulation wave frequency can be modified by multi-functional knob or press **ModFreq**, enter the number by numeric keypad and select unit.

● Set Phase Deviation

The phase deviation indicates the change between the phases of PM modulated waveform and the phase of carrier wave phase. Settable range of PM phase deviation is from 0° to 360°, and the default value is 180°. After enabling PM function, the phase deviation can be modified by multi-function knob and direction keys, or pressing **PhaseDev**.

● Comprehensive Example

First run the instrument in phase modulation (PM) mode, and then set an internal sine wave of 200Hz as the modulation signal and a sine wave with frequency of 900Hz and amplitude of 100mVpp as the carrier signal. Finally set phase deviation to be 200°. The specific steps are as follows:

1) Enable Phase Modulation (PM) Function

Press **Mode** → **PM** to enable PM function.

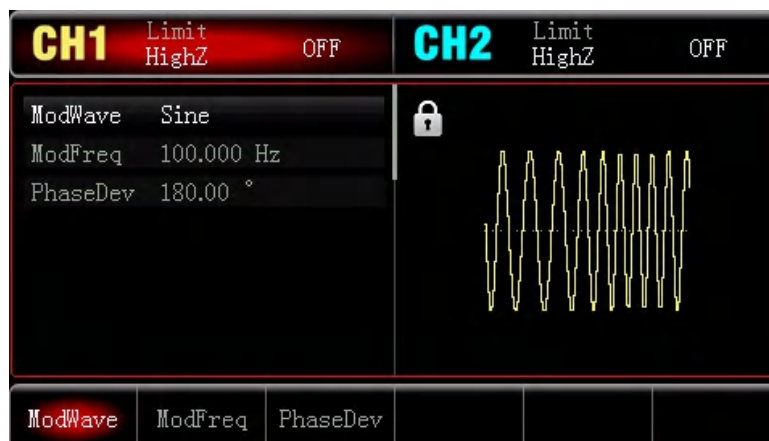

2) Set Modulation Signal Parameter

After step 1), press **ModFreq**, enter 200 by numeric keypad, and select parameter unit **Hz**.

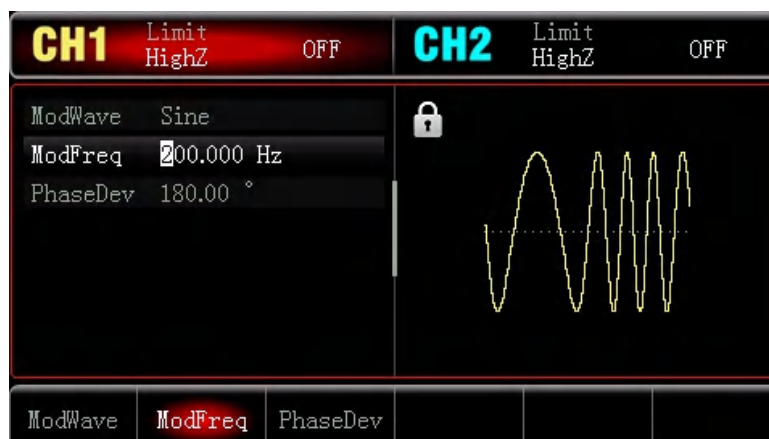

3) Set Waveform and Parameter of Carrier Wave Signal

Press **Wave** → **Sine** to select sine wave (default) as carrier waveform.

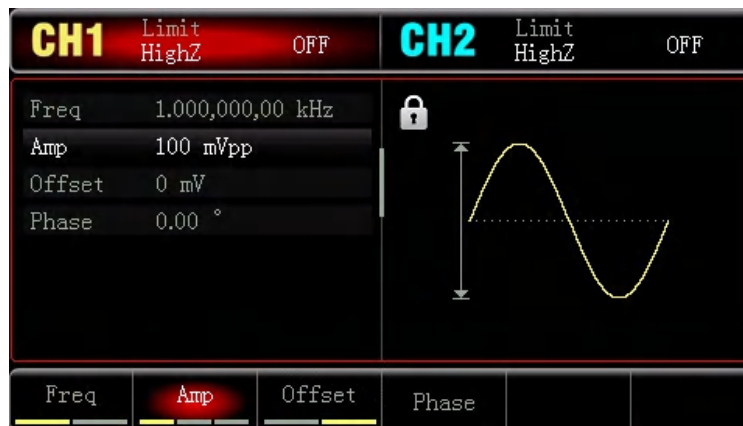

Press **Freq** to set frequency, enter 900 by numeric keypad, and select parameter unit **Hz**.

Press **Amp** to set amplitude, enter 100, and select parameter unit **mVpp**.

As the picture shown:



4) Set Phase Deviation

After setting the carrier wave parameters, press **Mode** → **PM** to enable PM function.

Press **PhaseDev** and enter 200, select parameter unit **°**.

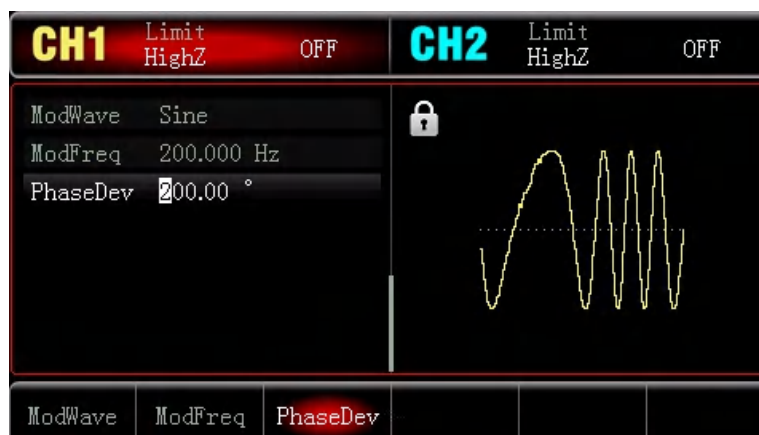

5) Enable Channel Output

Press **CH1** to enable the channel 1 output quickly. Backlight of the CH1 key will be turn on.

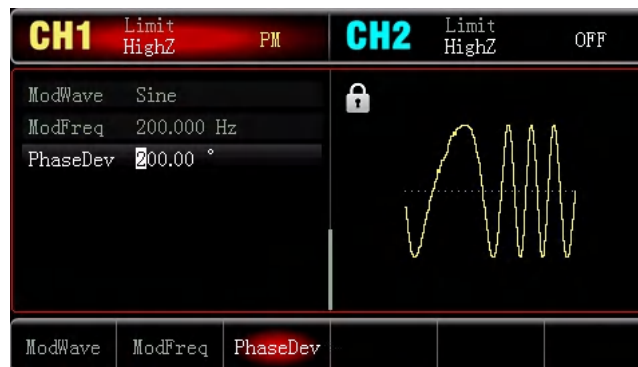

The PM modulation waveform in oscilloscope is shown below:

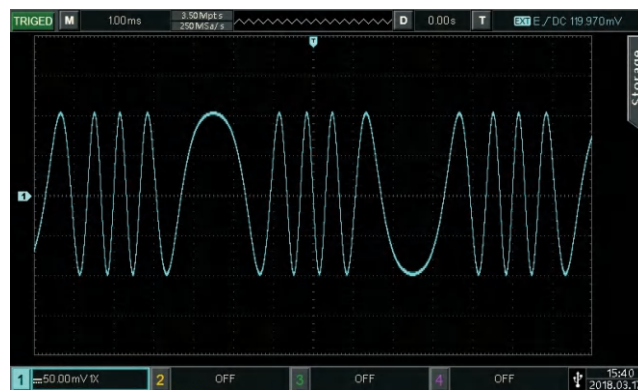

4.1.3 Frequency Modulation (FM)

In FM modulation, modulated waveform is usually composed of carrier wave and modulation wave. The frequency of carrier wave will vary with amplitude of modulation wave.

Press **Mode** → **FM** to enable the FM function, the device will output modulated waveform with current set modulation waveform and carrier wave.

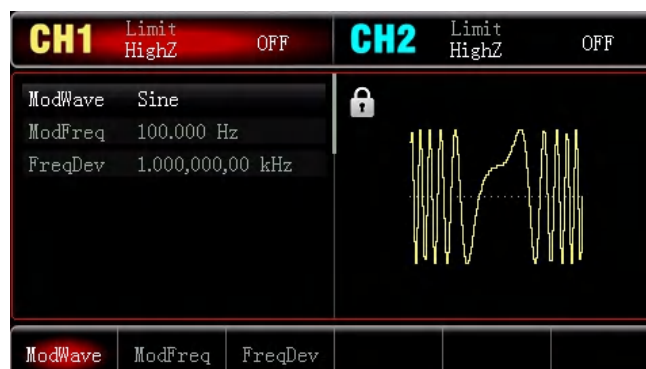

- **Select Carrier Waveform**

After selecting FM modulation, press **Wave** to select carrier waveform, which can be: sine (default), square, ramp or arbitrary wave.

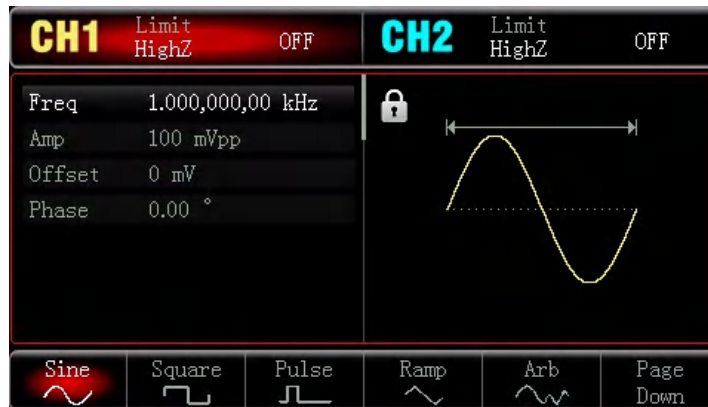

- **Set the Carrier Frequency**

Please refer to the AM carrier waveform setting.

- **Select Modulation Wave**

Modulation source of device is internal. And modulation wave can be: sine (default), square, rising/falling ramp, arbitrary wave or noise. After enabling FM function, the default modulation source can be modified by multi-functional knob or press **ModWave**.

- Square wave: duty ratio is 50%
- Rising ramp wave: symmetry degree is 100%
- Falling ramp wave: symmetry degree is 0%
- Arbitrary wave: when arbitrary wave is selected to be modulation wave, function/arbitrary waveform generation limits arbitrary wave length as 4kpts through auto snapshot.
- Noise: White gauss noise



- **Set Modulation Wave Frequency**

Set the modulation wave frequency, range is 2mHz~200kHz (default to 100Hz). After enabling FM function, the default modulation wave frequency can be modified by multi-functional knob or press **ModFreq**, enter the number by numeric keypad and select unit.

- **Set Frequency Deviation**

The frequency deviation indicates the change between the phases of FM modulated waveform and the phase of carrier wave phase. Settable range of PM frequency deviation is from DC to half of current carrier wave bandwidth, and the default value is 1kHz. After enabling FM function, the phase deviation can be modified by pressing **FreqDev**.

- Frequency deviation \leq carrier wave frequency, if the value of frequency deviation is set higher than carrier wave frequency, the device will automatically set the offset value to the maximum allowable carrier wave frequency.
- Frequency deviation + carrier wave frequency \leq the allowed maximum frequency of current carrier wave. If the frequency deviation value is set to an invalid value, the device will automatically set the offset value to the maximum allowable carrier wave frequency.

- **Comprehensive Example**

First run the instrument in frequency modulation (FM) mode, set an internal square wave of 2kHz as the modulation signal and a sine wave with frequency of 10kHz and amplitude of 100mVpp as the carrier signal. Finally set phase deviation to be 5kHz. The specific steps are as follows:

1) Enable Frequency Modulation (FM) Function

Press **Mode** → **FM** to enable FM function.

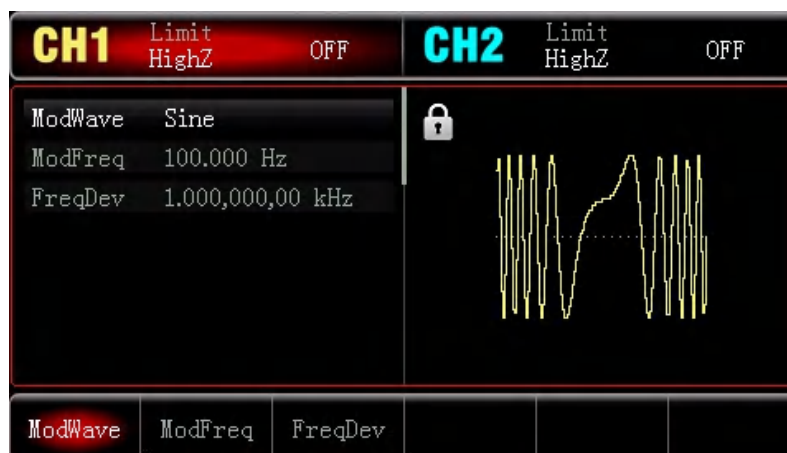

2) Set Modulation Signal Parameter and Waveform

After step 1), press **ModWave** → **Square** to select square wave as modulation waveform. Press **ModFreq**, enter 2 by numeric keypad, and select parameter unit **kHz**.



3) Set Waveform and Parameters of Carrier Wave Signal

Press **Wave** → **Sine** to select sine wave (default) as carrier waveform.

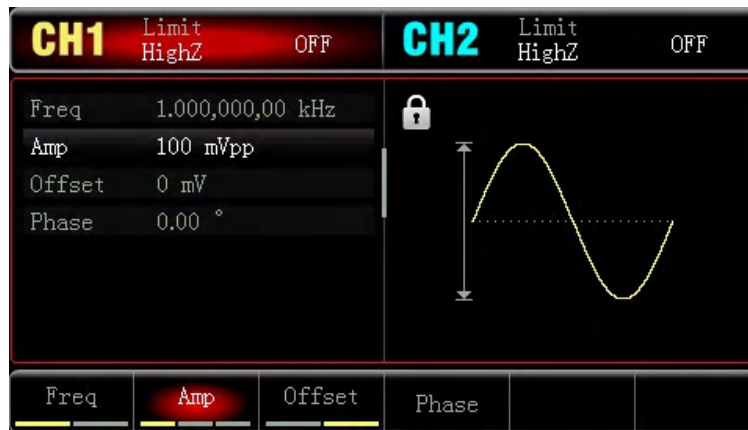

Press **Freq** to set frequency, enter 10 by numeric keypad, and select parameter unit **kHz**.
 Press **Amp** to set amplitude, enter 100 by numeric keypad, and select parameter unit **mV**.



4) Set Frequency Deviation

After setting the carrier wave parameters, press **Mode** → **ModFreq** to enter modulation frequency setting.

Press **FreqDev** and enter 5, select parameter unit **kHz**.

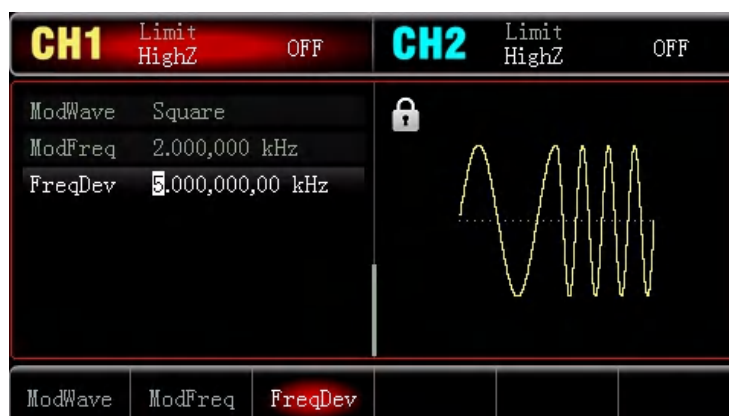

5) Enable Channel Output

Press **CH1** to enable the channel 1 output quickly. Backlight of the CH1 key will be turn on.

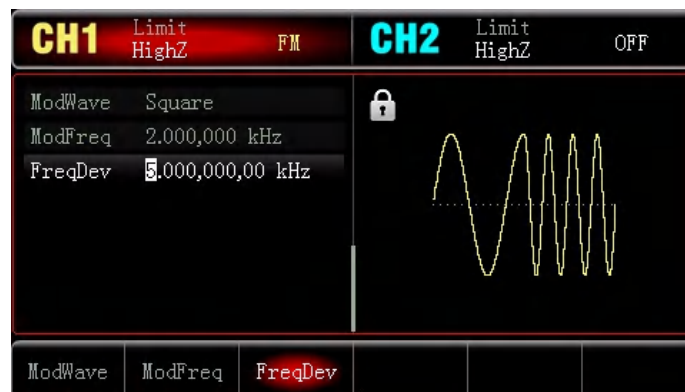

The FM modulation waveform in oscilloscope is shown below:

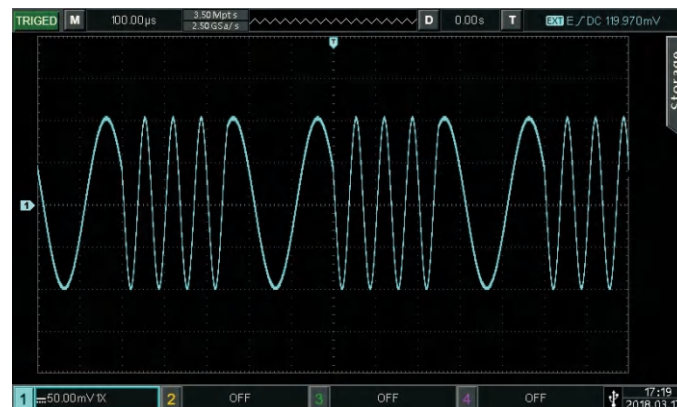

4.1.4 Frequency Shift Keying (FSK)

In frequency shift keying mode, moving rate between carrier wave frequency and hopping frequency can be set.

- **Select FSK Modulation**

Press **Mode** → **FSK** to enable the FSK function. The device will output modulated waveform with current setting.

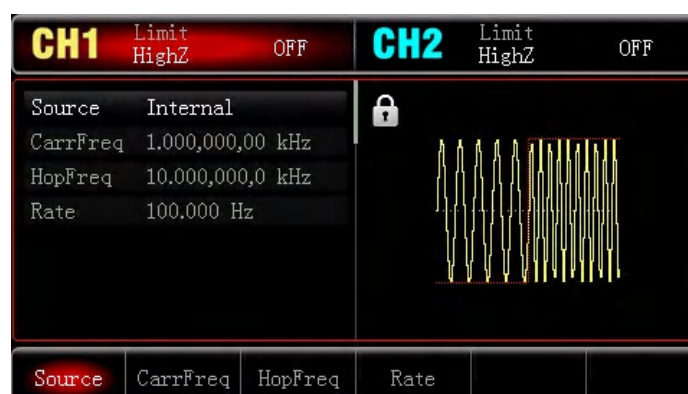

- **Select Carrier Waveform**

Press **Mode** → **FSK** → **Wave** to select carrier waveform, which can be: sine wave (default), square wave, ramp wave or arbitrary wave.



- **Set the Carrier Frequency**

Please refer to the AM carrier waveform setting.

- **Select the Modulation Source**

The device can select internal or external modulation source. After enabling FSK function, the default modulation source is internal. You can change it to external modulation source by multi-functional knob or pressing **Source** → **External**.

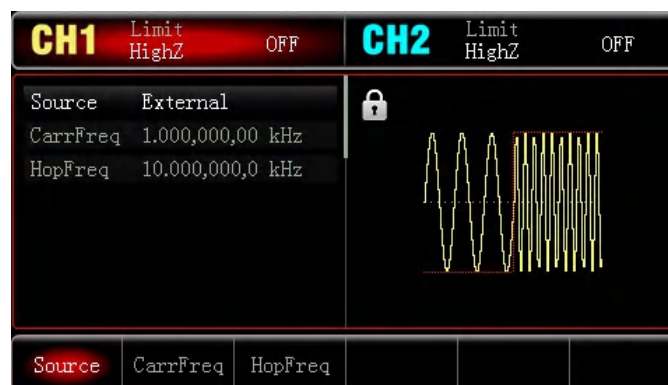

1) Internal Source

When modulation source is internal, internal modulation wave is a square wave of 50% duty ratio (not adjustable). The FSK rate can be set to customize the moving rate between carrier wave frequency and hop frequency.

2) External Source

When modulation source is external, carrier waveform will be modulated by an external waveform. FSK output frequency is determined by the logic level of external digital modulation interface (INPUT/CNT interface). For example, output the carrier wave frequency when external output logic is low, and output hop frequency when external input logic is high.

- **Set Hop Frequency**

After enabling FSK function, the default hop frequency is 10kHz. You can change it by multi-functional knob and direction keys, or pressing **HopFreq**, enter numbers, then select corresponding unit. Settable range of hop frequency is determined by carrier wave waveform. The carrier wave frequency setting refers to AM carrier wave frequency setting.

- **Set FSK Rate**

When modulation source is internal, the moving rate between carrier wave frequency and hop frequency can be set. After enabling FSK function, FSK rate can be set and the settable range is 2mHz to 100kHz, the default rate is 100Hz. You can change it by multi-functional knob and direction keys, or pressing **Rate**, enter numbers, then select corresponding unit.

- **Comprehensive Example**

Firstly, run the instrument in frequency shift keying (FSK) mode, then set an internal sine wave with 2kHz and 1Vpp as a carrier wave signal, set hop frequency to 800 Hz, then make carrier wave frequency and hop frequency move between each other with 200Hz frequency. Specific steps are seen as following:

1) Enable Frequency Shift Keying (FSK) Function

Press **Mode** → **FSK** to start the FSK function.

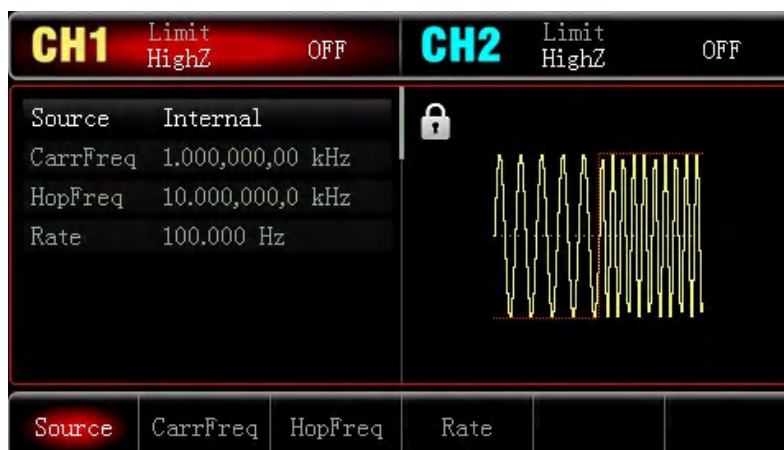

2) Set Hop Frequency

After step 1), press **HopFreq**, enter 800 by numeric keypad, and select parameter unit **Hz**.

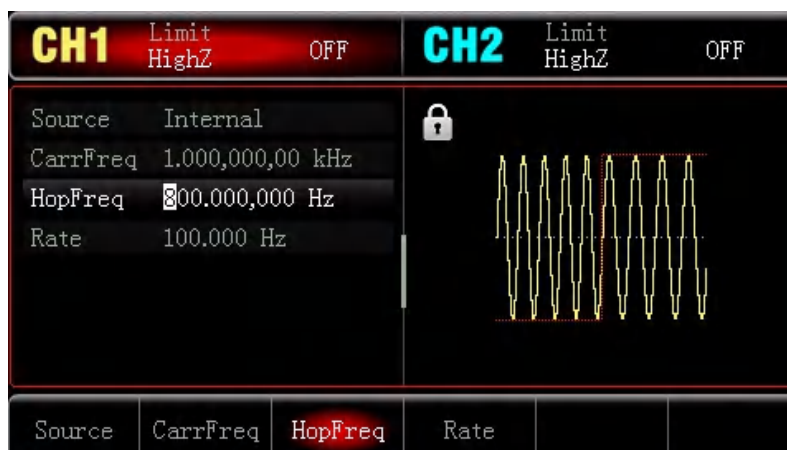

3) Set Modulation Rate

Press **[Rate]**, enter 200 by numeric keypad and select parameter unit **[Hz]**.

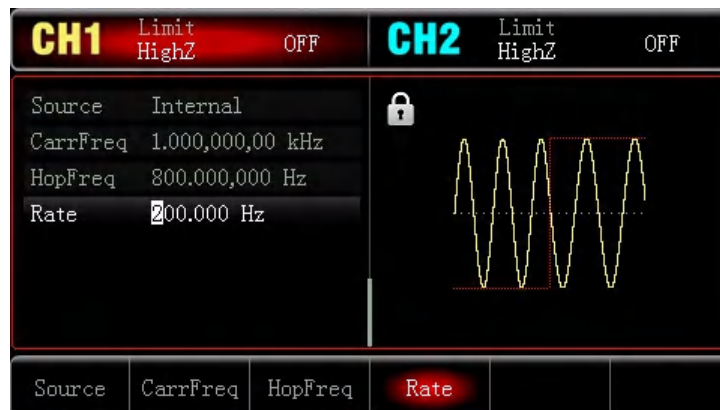

4) Set Carrier Wave Signal

Press **[Wave]** → **[Sine]** to select sine wave (default) as carrier waveform.



Press **[Freq]** to set frequency, enter 2 by numeric keypad, and select parameter unit **[kHz]**.

Press **[Amp]** to set amplitude, enter 1 by numeric keypad, and select parameter unit **[Vpp]**.



5) Enable Channel Output

Press **CH1** to enable the channel 1 output quickly. Backlight of the CH1 key will be turn on.

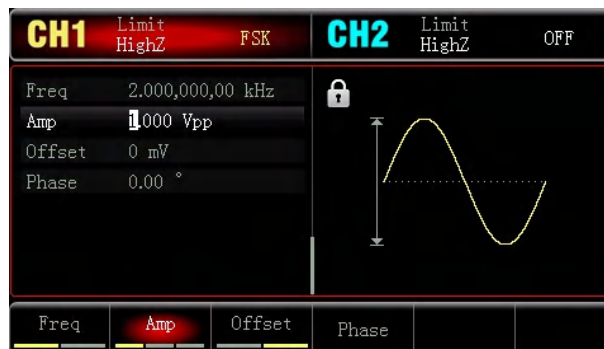

The FSK modulation waveform in oscilloscope is shown as following:

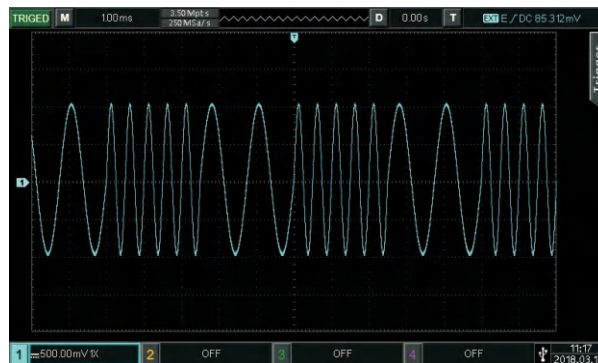

4.2 Output Frequency Sweep Waveform

When selecting frequency sweep mode in designated time, the device can generate frequency sweep output for sine wave, square wave, ramp wave and arbitrary wave (except DC) in a linear or logarithmic way.

4.2.1 Select Frequency Sweep

Start Frequency Sweep

Press **Mode** → **Line** to enable frequency sweep, the generator will output frequency sweep waveform with the current setting. Output linear frequency sweep setting is as shown:

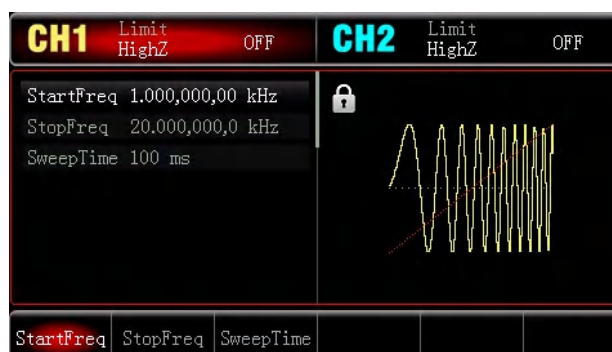

Select Frequency Sweep Waveform

After selecting frequency sweep function, press **Wave** to select frequency sweep carrier waveform, which can be: sine (default), pulse, ramp or arbitrary wave.

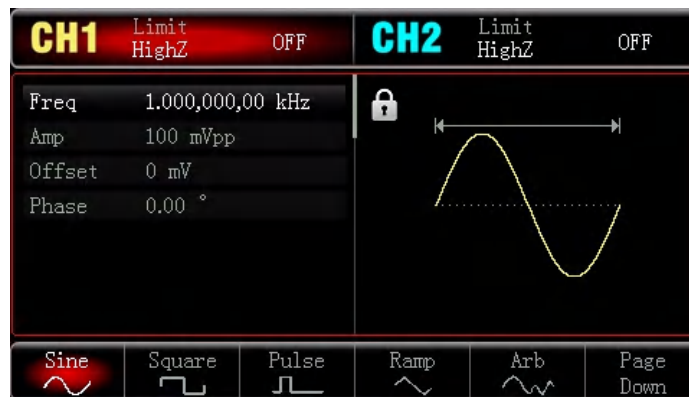

4.2.2 Set Starting and Stop Frequency

Starting frequency and stop frequency are upper limit and lower limit of frequency sweep. Function/arbitrary waveform generator always sweeps from starting frequency to stop frequency and then returns to starting frequency. To set starting or stop frequency, please press **Mode** → **Line**, use multi-functional knob and direction keys, or pressing **StartFreq** / **StopFreq**, enter number and select corresponding unit to finish setting.

- When starting frequency < stop frequency, DDS waveform generator sweeps from low frequency to high frequency.
- When starting frequency > stop frequency, DDS waveform generator sweeps from high frequency to low frequency.
- When starting frequency = stop frequency, DDS waveform generator outputs fixed frequency. By default, starting frequency is 1kHz and stop frequency is 20kHz, but the range of starting and stop frequency are vary with different frequency sweep waveform. See the table below for the frequency range of frequency sweep wave:

Carrier waveform	Frequency			
	UTG932E		UTG962E	
	Maximum	Minimum	Maximum	Minimum
Sine wave	1 μ Hz	30MHz	1 μ Hz	60MHz
Square wave	1 μ Hz	15MHz	1 μ Hz	20MHz
Ramp wave	1 μ Hz	400kHz	1 μ Hz	400kHz
Pulse wave	1 μ Hz	15MHz	1 μ Hz	20MHz
Arbitrary wave	1 μ Hz	10MHz	1 μ Hz	10MHz

4.2.3 Frequency Sweep Mode

Press **Mode** → **Line/Log** to choose the linear or logarithmic way that the generator will use to change output frequency.

4.2.4 Frequency Sweep Time

Set the time from starting frequency to stop frequency, which is 1s by default and in the range of 1ms~500s. To change it, you can press **SweepTime** in frequency sweep setting interface, input number by numeric keyboard and select corresponding unit.

4.2.5 Comprehensive Example

Enable frequency sweep mode, then set a square wave signal of 1Vpp amplitude and 50% duty ratio as frequency sweep wave. The frequency sweep mode is linear. Set starting frequency to be 1kHz, stop frequency to be 50kHz and frequency sweep time to be 2ms. The specific steps are as follows:

1) Enable Frequency Sweep Function

Press **Mode** → **Line** successively to start linear frequency sweep function.

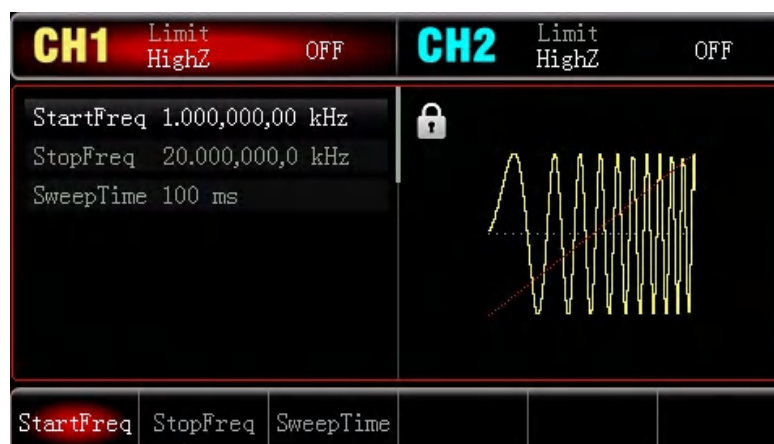

2) Select Frequency Sweep Waveform

Press **Wave** to select frequency sweep waveform, then press **Square** to select square wave (default to sine)



Press **Amp** to set amplitude, enter 1 by numeric keypad, and select parameter unit **Vpp**.

Press **Duty** to set duty ratio, enter 50 (default) by numeric keypad, and select parameter unit **%**.

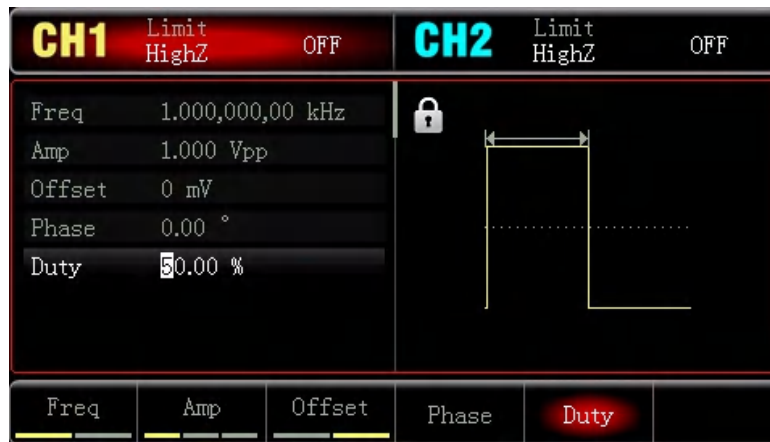

3) Set Starting/stop Frequency, Frequency Sweep Time

Press **Mode** → **Line** to enter linear frequency sweep:

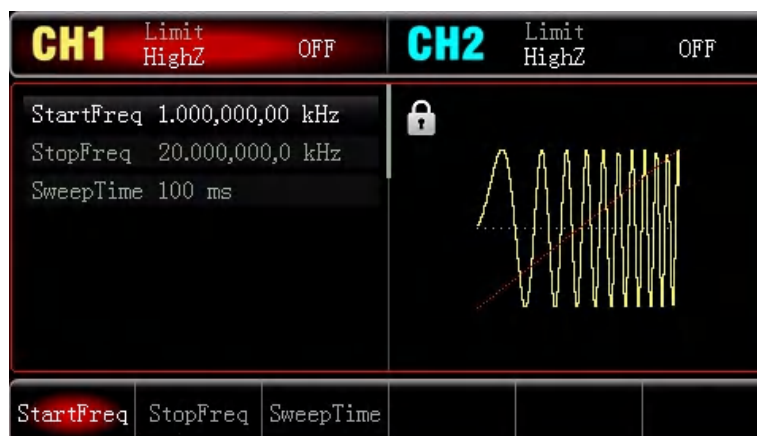

Press **StartFreq** / **StopFreq**, enter 1 by numeric keypad, and select the parameter unit **kHz**.

The start frequency is 1kHz by default.

Press **StopFreq**, enter 50 by numeric keypad, and select the parameter unit **kHz**.

Press **SweepTime**, enter 2 by numeric keypad, and select the parameter unit **ms**.



4) Enable Channel Output

Press **CH1** to enable the channel 1 output quickly. Backlight of the CH1 key will be turn on as well.

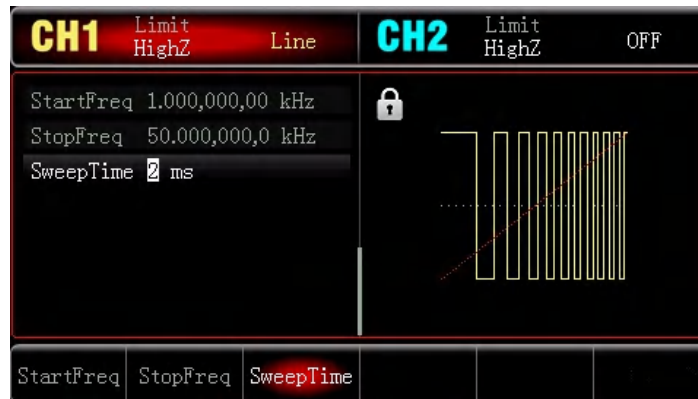

The shape of frequency sweep waveform in oscilloscope is shown below:

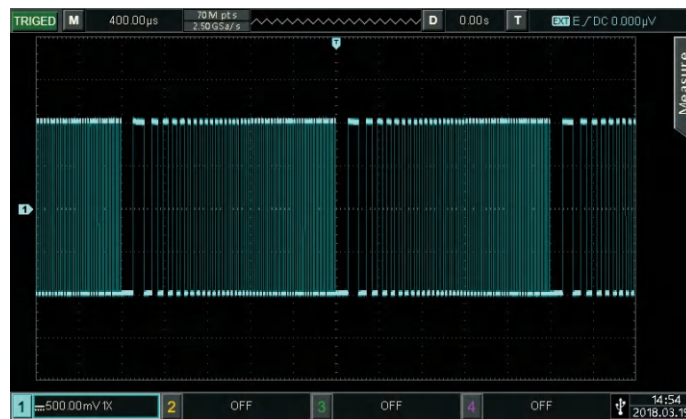

4.3 Output Arbitrary Wave

UTG900 stores 26 types of arbitrary waveform (See the list of built-in arbitrary wave).

4.3.1 Enable Arbitrary Wave Function

Press **Wave** → **Arb** to enable arbitrary wave function. The generator will output arbitrary waveform with the current setting.



4.3.2 Select Arbitrary Wave

UTG900 allows users to select build-in arbitrary waveform. In arbitrary wave function, users can select the arbitrary wave by multi-functional knob and direction keys or by pressing

WaveFile to select arbitrary waveforms as needed.

List of built-in arbitrary wave:

0	AbsSine
1	AmpALT
2	AttALT
3	Cardiac
4	CosH
5	EEG
6	EOG
7	GaussianMonopulse
8	GaussPulse
9	LogNormal
10	Lorentz
11	Pulseilogram
12	Radar
13	Sinc
14	SineVer
15	StairUD
16	StepResp
17	Trapezia
18	TV
19	VOICE
20	Log2__up
21	Log2__down
22	tri__up
23	tri__down

Chapter 5 Fault Handling

Possible faults in use of UTG900 and troubleshooting methods are listed below. If these faults occur, please handle them according to corresponding steps. If they cannot be handled, please contact with your distributor or UNI-T local office, and provide the machine information which can be checked by pressing **Utility** → **System** → **About** in sequence.

No Display on Screen (Blank Screen)

If the signal generator still does not display after pressing power switch on front panel

- 1) Inspect whether power source is well connected.
- 2) Inspect whether power switch on back panel is well connected at "I".
- 3) Whether power switch on front panel is well connected.
- 4) Restart the instrument.
- 5) If the product still cannot be used normally, please contact with the dealer or local office.

No Waveform Output

Setting is correct but no waveform is output

- 1) Inspect whether BNC cable and channel output terminal are connected correctly.
- 2) Inspect whether **CH1** or **CH2** is turned on.
- 3) If the product still cannot be used normally, please contact with the dealer or local office.

Chapter 6 Service and Support

6.1 Outline of Warranty

UNI-T (Uni-Trend Technology (China) Limited) guarantees that the products it produces and sells are free from any defects of material and process within 3 years from authorizing the dealer to deliver them. If the product is proven to be defective during warranty period, UNI-T will repair and replace according to provisions of warranty.

To arrange repair or ask for the whole warranty, please contact with the nearest sales or maintenance department of UNI-T.

Except warranties provided in the outline or other applicable warranties, UNI-T does not provide any other express or implied warranties, including but not limited to any implied warranties about tradability and applicability to special purpose of the product. In any case, UNI-T assumes no responsibility for any indirect, incidental, special or consequent loss.

6.2 Contact Us

If you have any inconvenience in use of the product, you can directly contact with Uni-Trend Technology (China) Co., Limited (UNI-T, Inc.) in mainland China, 8:00-17:30 on Monday to Friday, or e-mail us: infosh@uni-trend.com.cn.

Please contact with local dealer or sales center of UNI-T for products outside the mainland China. Service support, many products of UNI-T are equipped with plans for extending warranty period and calibration period. Please contact with local dealer or sales center of UNI-T. Please visit our website for the address list of service centers in various regions.

Website : <http://www.uni-trend.com>

Appendix A: Factory Reset State

Parameter	Factory default
Channel parameters	
Current carrier wave	Sine wave
Output load	HighZ
Sync output	Off
Channel output	Off
Channel output reverse phase	Off
Amplitude limit	Off
Upper amplitude limit	+10V
Lower amplitude limit	-10V
Fundamental wave	
Frequency	1kHz
Amplitude	100mVpp
DC offset	0mV
Initial phase	0°
Duty ratio of square wave	50%
Symmetry of ramp wave	100%
Duty ratio of pulse wave	50%
Rising edge of pulse wave	15ns
Falling edge of pulse wave	15ns
Arbitrary wave	
Built-in arbitrary wave	AbsSine
AM modulation	
Modulation source	Internal
Modulation wave	Sine wave
Modulation frequency	100Hz
Modulation depth	100%
FM modulation	
Modulation source	Internal
Modulation wave	Sine wave
Modulation frequency	100Hz
Frequency deviation	1kHz

PM modulation	
Modulation source	Internal
Modulation wave	Sine wave
PM frequency	100Hz
Phase deviation	180°
FSK modulation	
Modulation source	Internal
FSK rate	100Hz
Hopping frequency	2MHz
Frequency sweep	
Type of frequency sweep	Linear
Starting frequency	1kHz
Stopping frequency	20kHz
Frequency sweep time	100ms
System parameter	
Sound of buzzer	On
Separator of numbers	,
Backlight	100%
Language *	Depends on factory setting

Appendix B: Performance Index

Unless otherwise stated, when the following two conditions are satisfied, all the technical index specifications can be guaranteed.

1. The signal generator is in the calibration cycle and has been calibrated.
2. The signal generator has operated for over 30 minutes within specified temperature (18°C-28°C).

All specifications are guaranteed except those marked "typical value".

Model	UTG932E		UTG962E	
Channel	Dual channels		Dual channels	
Max frequency	30MHz		60MHz	
Sampling rate	200MSa/s			
Waveform	Sine wave, square wave, ramp wave, pulse wave, noise, DC, arbitrary wave			
Working modes	Output gating, continuous, modulation, frequency sweep			
Modulation types	AM, FM, PM, FSK, Line, Log			
Frequency characteristic				
Sine wave				
Frequency range	1μHz~30MHz		1μHz~60MHz	
Resolution	1μHz			
Accuracy	within 90 days: ±50ppm, within 1 year: ±100ppm (18°C-28°C)			
Harmonic distortion (typical value)	Test condition: output frequency 0dBm			
	DC~5MHz	-60dBc		
	5MHz~30MHz	-50dBc		
	30MHz~60MHz	-40dBc		
THD (typical value)	<0.2%(DC~20kHz, 1Vpp)			
Spurious signal (non-harmonic wave, typical value)	test condition: output power 0dBm			
	DC~10MHz, <-70dBc			
	> 10MHz < -70dBc+6dB/octave			
Phase noise (typical value)	10 MHz: ≤ -125dBc/Hz (typical, 0dBm, 10kHz deviation)			
Square wave				
Frequency range	1μHz~15MHz		1μHz~20MHz	
Resolution	1μHz			
Rise/fall time	<16ns (typical value, 1kHz, 1Vpp)			
Overshoot (typical value)	<2%			
Duty ratio	0.01%~99.99% (limited by current frequency)			
Symmetry (50% duty ratio)	1ns + 100ppm of period			

Shake (typical value)	Typical value (1MHz, 1Vpp, 50Ω)	
	≤5MHz: 2ppm+200ps	
	>5MHz: 200ps	
Ramp wave		
Frequency	1μHz~400kHz	1μHz~400kHz
Resolution	1μHz	
Nonlinearity	3%±2mV (typical value, 1kHz, 1Vpp, symmetry 50%)	
Symmetry	0.0% ~ 100.0%	
Pulse wave		
Frequency	1μHz~15MHz	1μHz~20MHz
Resolution	1μHz	
Pulse width	≥22ns	
Variable edge	15ns~8s	15ns~8s
Overshoot	<2% (typical value 1Vpp)	
Shake	150ps	
Gauss noise		
Bandwidth	30MHz(-3dB) (typical value))	60MHz(-3dB) (typical value))
DC offset		
Range (peak AC+DC)	±5V(50Ω)	
	±10V (high resistance)	
Offset accuracy	±3% of offset set value ±6% of amplitude value ±2mV	
Arbitrary wave characteristics		
Frequency range	1μHz~10MHz	1μHz~10MHz
Resolution	1μHz	
Wave length	4kpts	
Vertical resolution	14bits (symbol included)	
Sampling rage	200MSa/s	
Minimum rising/ falling time	< 20ns typical value	< 20ns typical value
Shake	5ns±150ps	
Nonvolatile storage	24 waveforms	

Output characteristics		
Amplitude range	$\leq 10\text{MHz}$: 1mVpp~10Vpp; (50 Ω)	
	$\leq 60\text{MHz}$: 1mVpp~5Vpp; (50 Ω)	
Accuracy (1kHz sine wave)	$\pm(5\%$ of set value+2mVpp)	
Amplitude flatness (equal to 1kHz sine wave, 1Vpp/50 Ω)	Test condition: typical value (sine wave, 2.0Vpp)	
	$\leq 100\text{kHz}$: $\pm 0.1\text{dB}$; $\leq 20\text{MHz}$: $\pm 0.3\text{dB}$; $\leq 30\text{MHz}$: $\pm 0.5\text{dB}$; $\leq 40\text{MHz}$: $\pm 0.6\text{dB}$; $\leq 60\text{MHz}$: $\pm 0.8\text{dB}$	
Waveform output		
Impedance	50 Ω typical value	
Insulation	Maximum 42Vpk to ground wire	
Protection	Channel protection	
Modulation types		
AM modulation		
Carrier wave	Sine wave, square wave, ramp wave, arbitrary wave	
Source	Internal	
Modulation wave	Sine wave, square wave, ramp wave, noise, arbitrary wave	
Modulation frequency	2mHz~200kHz	
Modulation depth	0%~120%	
FM modulation		
Carrier wave	Sine wave, square wave, ramp wave, arbitrary wave	
Modulation wave	Sine wave, square wave, ramp wave, noise, arbitrary wave	
Modulation frequency	1 μHz ~200kHz	
Frequency deviation	DC~15MHz	DC~30MHz
PM modulation		
Carrier wave	Sine wave, square wave, ramp wave, arbitrary wave	
Modulation wave	Sine wave, square wave, ramp wave, noise, arbitrary wave	
Modulation frequency	2mHz~200kHz	
Phase deviation	0°~360°	
FSK modulation		
Carrier wave	Sine wave, square wave, ramp wave, arbitrary wave	
Source	Internal/external	
Modulation wave	Square wave (Duty ratio 50%)	
Rate	2mHz~100kHz	

Frequency sweep	
Carrier wave	Sine wave, square wave, ramp wave, arbitrary wave
Type	Linear or logarithmic
Frequency sweep time	1ms~500s ± 0.1%
Sync signal	
Output level	TTL compatible
Output frequency	1μHz~2MHz
Output frequency	50Ω, typical value
Coupled mode	DC
Trigger input	
Input level	TTL compatible
Input impedance	> 10kΩ, DC coupling
Frequency counter	
Input level	TTL compatible
Range of input frequency	100mHz~100MHz
Accuracy	±51ppm
Frequency resolution	7 digit
Coupled mode	DC
General technical specifications	
Display	
Display type	4.3 inches TFT LCD
Resolution	480×272
Power supply	
Power supply	DC5V, 2A
Power consumption	Less than 10W
Indoor use	
Temperature range	Operation: 10°C~+40°C
	Storage: -20°C~+60°C
Cooling method	Natural cooling
Humidity range	Below +35°C: ≤90% relative humidity
	+35°C~+40°C: ≤60% relative humidity
Altitude	Below 2,000m
Mechanical specification	
Dimensions	172mm×90mm×68mm
Net weight	0.33kg
Rough weight	0.77kg

Appendix C: List of Accessories

Model	UTG900E
Standard configuration	A power line up to local standard
	A BNC-alligator clip cable
	A BNC cable (1 m)

Power adapter:

Power voltage	100-240Vrms 50/60Hz 0.4A
Output voltage	5VDC
Output current	2A

Appendix D: Maintenance and Cleaning

General maintenance

- Please don't store or place the instrument where LCD is exposed to direct sunlight for a long time.
- To avoid damage to the instrument or connecting line, please don't place it in mist, liquid or solvent.

Cleaning

- Please clean the instrument frequently in the light of usage.
- Turn off the power first, clean the instrument casing with a damp cloth and mild detergent (do not use chemical detergent containing potent substances).
- Please prevent scratch of LCD screen when cleaning.
- Please protect the instrument against any corrosive liquid to prevent damage.

Warning: please ensure the instrument is completely dry before turn it on to prevent electrical short circuit or personal injury.

UNI-T®**UNI-TREND TECHNOLOGY (CHINA) CO., LTD.**

No. 6, Gong Ye Bei 1st Road,
Songshan Lake National High-Tech Industrial
Development Zone, Dongguan City,
Guangdong Province, China
Tel: (86-769) 8572 3888
www.uni-trend.com

